

R1	Current
0R1	1A
0R2	500mA
0R5	250mA

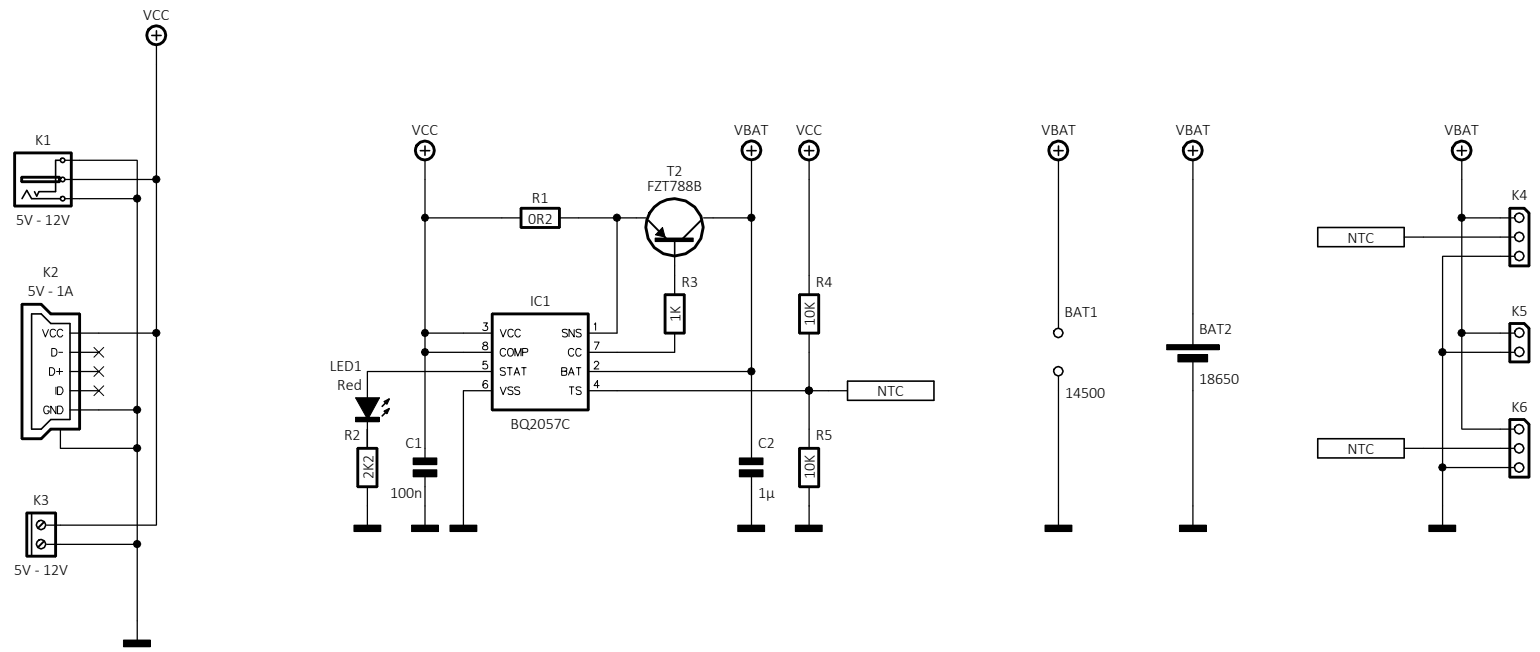

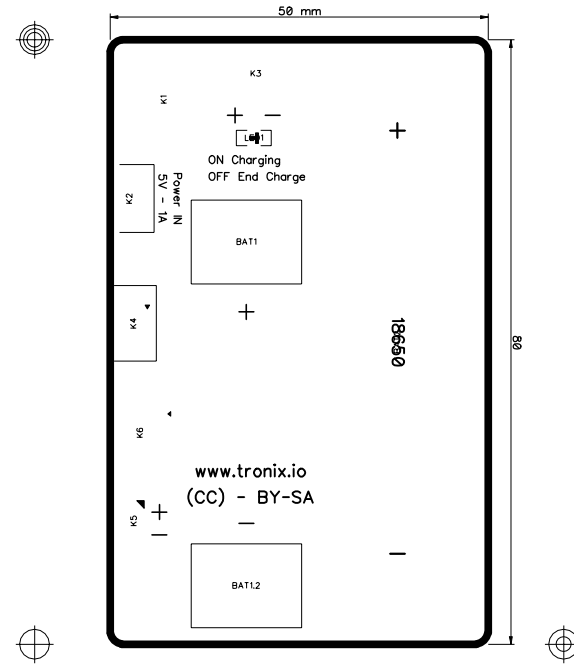

TCharger - (12/2017) - SCALE: 100%

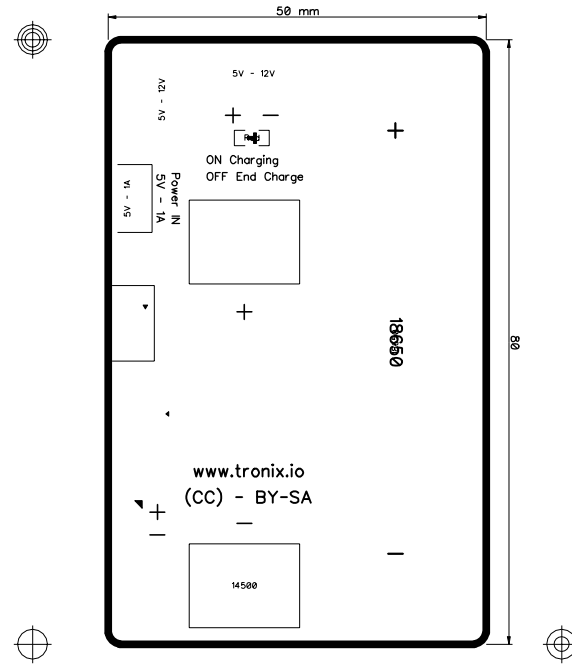

TCharger - (12/2017) - SCALE: 100%

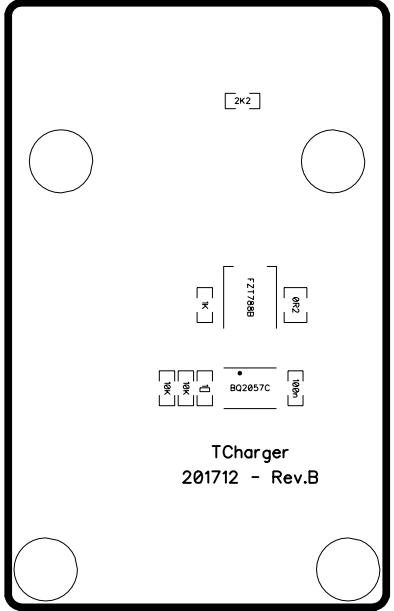

TCharger - (15\5017) - SCALE: 100%

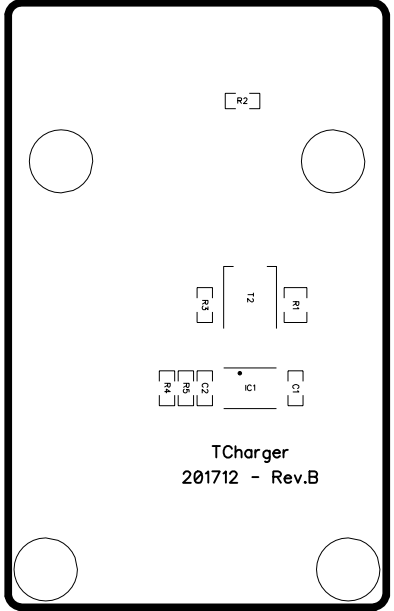

TCharger - (15\5017) - SCALE: 100%

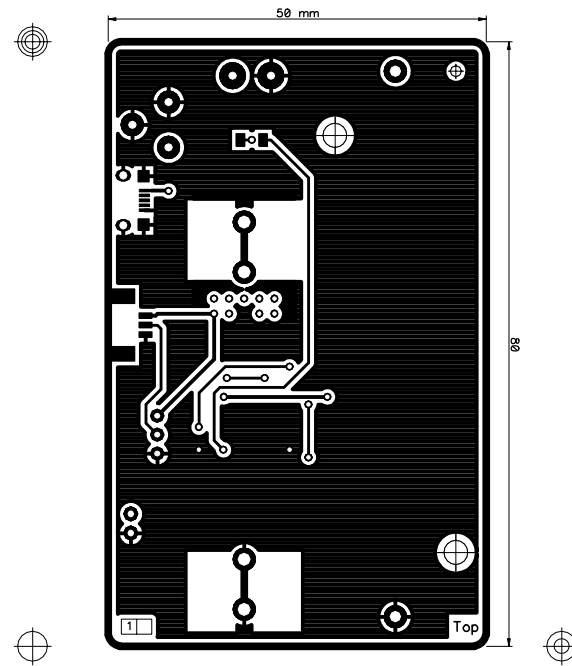

TCharger - (12/2017) - SCALE: 100%

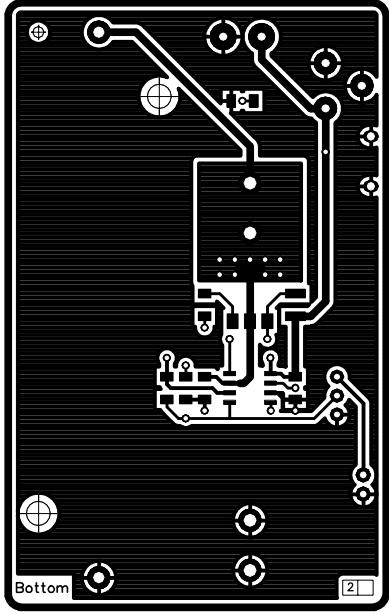

T:\order - (15\5017) - SCALE: 100%