

1

2

3

4

5

6

A

B

C

D

A

B

C

D

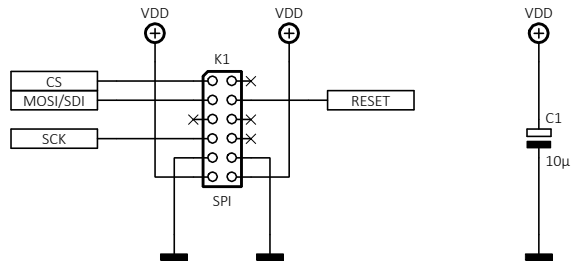

0100000x	0x40
0100001x	0x42
0100010x	0x44
0100011x	0x46

LED	RESISTOR
BLUE	1K6
RED	2K
GREEN	2K7
ORANGE	2K2

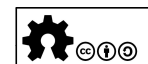
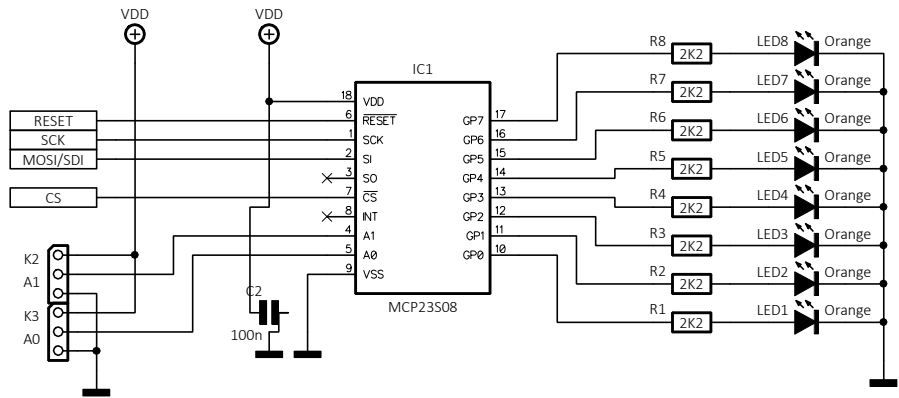

<http://creativecommons.org/licenses/by-sa/4.0/>

<http://www.tronix.io/>

MCP23S08 LED

12/2017 Rev.B

1

2

3

4

5

6

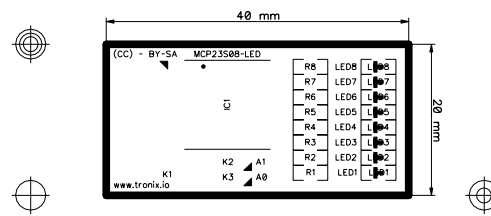

MCP23S08-LED - (12/2017) - SCALE: 100%

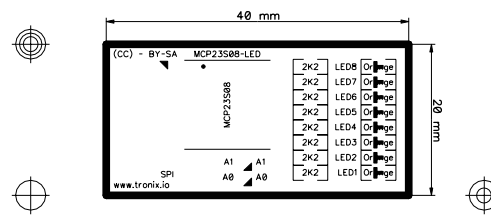

MCP23S08-LED - (12/2017) - SCALE: 100%

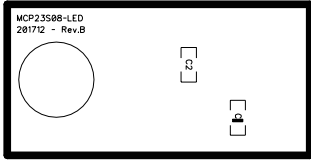

MCP23208-LED - (15\5017) - SCALE: 100X



MCP3208-LED - (15\5017) - 2SCALE: 100x

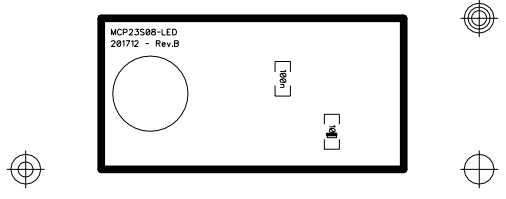

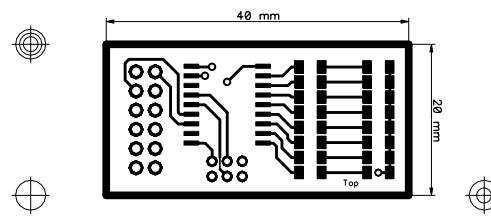

MCP23S08-LED - (12/2017) - SCALE: 100%

MCP3208-LED - (15\5017) - SCALE: 100x

